

# Test Automation of Motor Over Temperature Protection Extension Module of Drive

**Renu Kashyap<sup>1</sup>, Mr. Swaraj Samal<sup>2</sup>, Dr. V. Karthikeyan<sup>3</sup>**

<sup>1,3</sup>Dept. of Electrical Engineering National Institute of Technology Calicut, Kerala, India.

<sup>2</sup>ABB Global Industries Services Private Limited, Bengaluru, India.

**Email:** renukashyap20021@gmail.com<sup>1</sup>, swaraj.cpp@gmail.com<sup>2</sup>, Karthikeyan@nitc.ac.in<sup>3</sup>

## Abstract

In industries, for releasing any product into the market, various stages of testing procedure must be done on the product to test its functionality and reliability. The testing procedure has to be frequent and accurate enough to enable early defect detection. Manual testing procedures are time-consuming, need more human resources at the place of testing, have no concept of documentation, and have more chances of human errors. To overcome the variously described limitations of manual testing, test automation is a key tool for providing prompt feedback, tracking of developed firmware versions time-to-time and reducing the tester's efforts to perform tests task repetitively. The main goal is to speed up test execution cycles and improve the accuracy as well as the performance of the module for end-user customer satisfaction. The proposed system works based on replacing the potentiometer with a relay configuration controlled by the digital output signal of the Programmable Logical Controller and Automated Test Framework. The study describes the transition from manual testing of modules with complex setup environments to automatic testing of modules with implemented hardware changes.

**Keywords:** PLC Automation, Test automation of modules, Motor Over Temperature Protection module testing, Manual to Automatic testing, and extension modules testing.

## 1. Introduction

In industries, increasing complexity due to manual testing of extension modules used for drives requires frequent and accurate automatic testing approaches. In CICD (Continuous Integration and Continuous Deployment) development, the released product or firmware undergoes various stages of testing the platform to see whether the developed product or firmware is effectively working as expected, on various products or drives as well as associated extension modules [1]. This research presents the journey from manual exploratory testing of an extension module known as a Motor over temperature protection module named “CPTC-02” [2] to Automated Test Framework (ATF)-based automatic testing with hardware changes required for it. These modules are externally connected to drive products which are meant to provide the basic feature of a backup supply to drive when a power-off situation happens, along with the special feature of motor thermal protection. This allows the use of the module in temperature protection of motors in explosive atmospheres.

To test its functionality for each release, various testing procedures which are written in test suites [1] are required, however all procedures were manually done by the testers team and had to invest too much time and effort. Therefore, automating manual exploratory testing to automatic testing has various advantages which are given as follows. (1) It reduces tester efforts to do the repetitive task of manual testing and at the same time handling instruments associated with the current test. (2) Performing manual exploratory testing requires many instruments as test setup e.g., Multimeters for relay output indication checkup, Potentiometers, etc., however after automating the tests, testing of modules is cost-effective for industries. (3) No human error, many accurate observations can be taken, quicker response than the action taken by the tester to perform test step, and achieving more exact calibrated measurement are the advantages of automatic testing (4) Though manual testing does not contain any proof of its assurance except for those testers who are involved in it, while in automatic testing, properly documented results which are called as test reports will be generated.

A promising framework for automating test processes to overcome the complexity of software components in automation systems that require systemic and frequent testing approaches was discussed in [1]. The work also presented that applying the framework in the industry will lead to improving automation systems' development and product quality. A journey from complex manual exploratory testing to automatic test generation in an industry for example was discussed in [3]. In the work, test generation was applied to a GUI-based

application developed in a large industrial project, and generated report described the successful application of test generation in a real-world industry project. The regression test framework to implement automation testing without script development during test development was discussed in [4]. The work also presented the whole procedure of designing the framework and showed how the framework supports regression tests using script-free technology. The test automation pyramid showed the disciplined way of doing test automation to create test scripts that validates the technical and functional aspects of software [5].

This research work is organized as follows: Section II discusses the overview of the existing manual testing procedures for a motor drive. Section III talks about the experiments, and the evaluation of the proposed method i.e., automated testing of the electrical drive. Section IV concludes the paper.

## **2. Overview of the Existing Manual Testing Procedures for Motor Over Temperature Module**

In the following section, the existing Manual testing procedures are described.

### **A. Motor Thermal Protection Extension Module of Drives**

The motor thermal protection module comprises of one relay that signals motor overheating in addition to a motor thermistor connection for monitoring the motor temperature. The relay output has to be linked to the drive's Safe Torque Off input in order for the drive to trip when the motor reaches a certain temperature. Between the motor thermistor connection and the other module connections, there is a strengthened insulation inside the module. The insulation creates a dependable protective barrier between the drive control circuits and the motor's main circuit. With the CPTC-02 module and a thermistor protection circuit added, the drive control unit is therefore compatible with Protective Extra Low Voltage.

### **B. Manual Testing Procedure to Test Module Functionality for Released Firmware/ Application**

The motor thermal protection module is having special feature of motor thermal protection in the explosive environment along with a basic application feature, hence testing the module functionality needs many stages of the testing platform [15]. For manual testing of this module, 3 different test cases are used to verify motor thermal protection functionality.

The work presented an exploratory manual analysis of the module. The procedure of generating automated test cases from manual testing took 7 months duration including hardware implementation.

Test setup implementation: The Positive Temperature Coefficient (PTC) sensor senses the resistance from the potentiometer and trips accordingly [7]. There is a list of instruments needed for doing manual testing (1) 24V SMPS power supply (2) Multimeter for relay output validation (3) Switches for connecting and disconnecting the potentiometer (4) Potentiometers used for providing resistance to PTC sensor (use of motor thermistor is not allowed for safety concern). Test setup implementation is shown in Fig.1.

### **C. Drawbacks of Existing Manual Testing Procedure**

During the time of releasing firmware/product, various testing procedures are needed to be performed frequently and accurately [8]. Manpower is needed for configuring the potentiometer as well as observing the multimeter carefully for the different conditions of relay tripping.

Time consumption to test all released products is the main drawback of manual testing. Also, except for the tester team who are involved in it, others do not have the proof of testing since the documentation of the whole test was not available [11]. Moreover, configuring potentiometer is prone to human error; so for the point of accuracy, a transition from manual testing to automatic testing is needed [9]. To overcome the above discussed drawbacks, a system for automatic testing of the motor over temperature module of a drive has been proposed.

## **3. Experiments and Evaluation of the Proposed System**

In this section, the proposed system is described based on relay operation which is controlled by a PLC 24v digital output signal, the concept of communication b/w PLC and drive through Profibus DP, and the concept of Automated test framework (ATF) [6] used for test automation scripts. The command to PLC, as well as drive, is written in ATF test script structure which is based on the coordination between manual testing reports and hardware design implementation [10].

From Fig. 2, it is clear that 4 relays are implemented for 3 different test cases which are energized by the 24V digital output of PLC. The communication protocol used between PLC and drive is Profibus DP, and the PC and drive are USB. These 3 test cases with their proper workflow are described in the upcoming section.

### A. Automated Testing of Drive with Proposed System

1) **Motor Over Temperature Protection Test:** The concept behind motor over temperature protection is that whenever drive connected motor reaches to very high temperature, the PTC sensor senses the equivalent resistance value through the motor thermistor which is connected to the PTC sensor, the fault is generated to drive, and the motor should stop. If any condition is not satisfying, the bug needs to log for the respective firmware. For testing at the lab, the motor thermistor is replaced by a potentiometer for security issues[12], by providing open circuit condition/ infinite resistance condition to PTC sensor, verifying all the test steps. When a connected potentiometer is provided 1kohm (equivalent to normal temperature conditions), the fault should be resettable, and the motor should run. The flow chart for this test is shown in Fig. 3.

2) **PTC Short Circuit Test:** The concept of the PTC short circuit test is that when a motor thermistor circuit is shorted due to any reason, it should be sensed by the PTC sensor (as zero resistance / short circuit condition is provided to the PTC sensor) and a fault must be generated, hence motor should stop running immediately. The fault should not be resettable as well as motor should not start. The flow chart for this test is shown in Fig. 4.

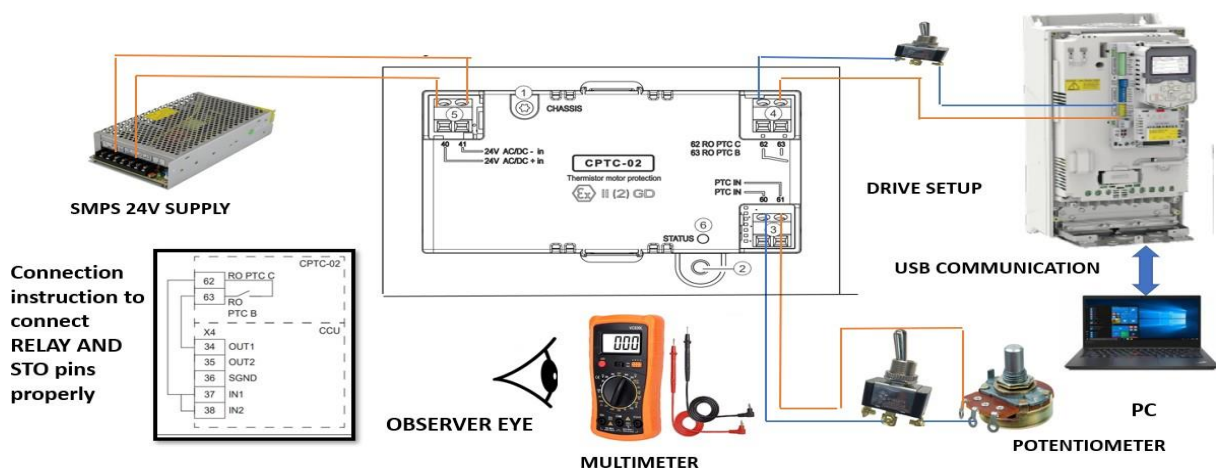
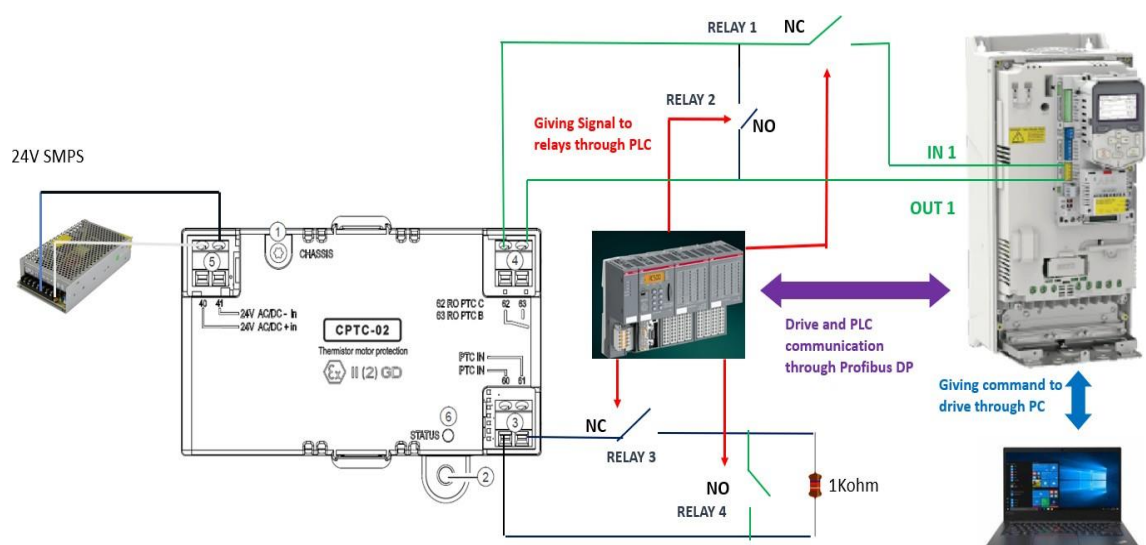

Figure 1. Manual Testing of Motor Over Temperature Module



**Figure 2.** Proposed System of Automatic Testing of Motor Over temperature Module

**3) Malfunctional Test:** From Fig. 2, it is clearly visible that the relay pins of the extension module are connected to STO pins of the drive. The concept behind the malfunction test is to make sure when the circuit is incomplete or not properly connected [16], it should show a warning of Relay malfunctions. So, for automating the test case, 2 relays which are used for short circuit and open-circuited conditions for relays pins are used. Relay 1 is used for providing disconnection between relay and drive STO pins, and relay 2 is used for short-circuited conditions near to relay pins. So, for both conditions, fault should be generated which should not be resettable. The first step is to provide disconnection (relay 1 is used) b/w STO pins and relay connection and check the warning. The second step is to connect back the connection between them, and when the warning is reset again, energize the relay 2 for the second condition of short circuit, check the warning and motor should not run. The flow chart for this test is shown in Fig. 5.

## B. Test Automation Setup

To investigate the effectiveness of automated testing and for validating the above 3 test cases whether all the test cases are perfectly automated and produce the same results as a manual test, all 3 test cases with required hardware changes are tested on the driver setup as shown in Fig.6.

### C. Automated Test Reports and Observations

#### 1) Automated Test Report of Motor Over Temperature Test:

For test automation, the ATF framework is used. All the steps are clearly visible by step markers used in the test report graphs.

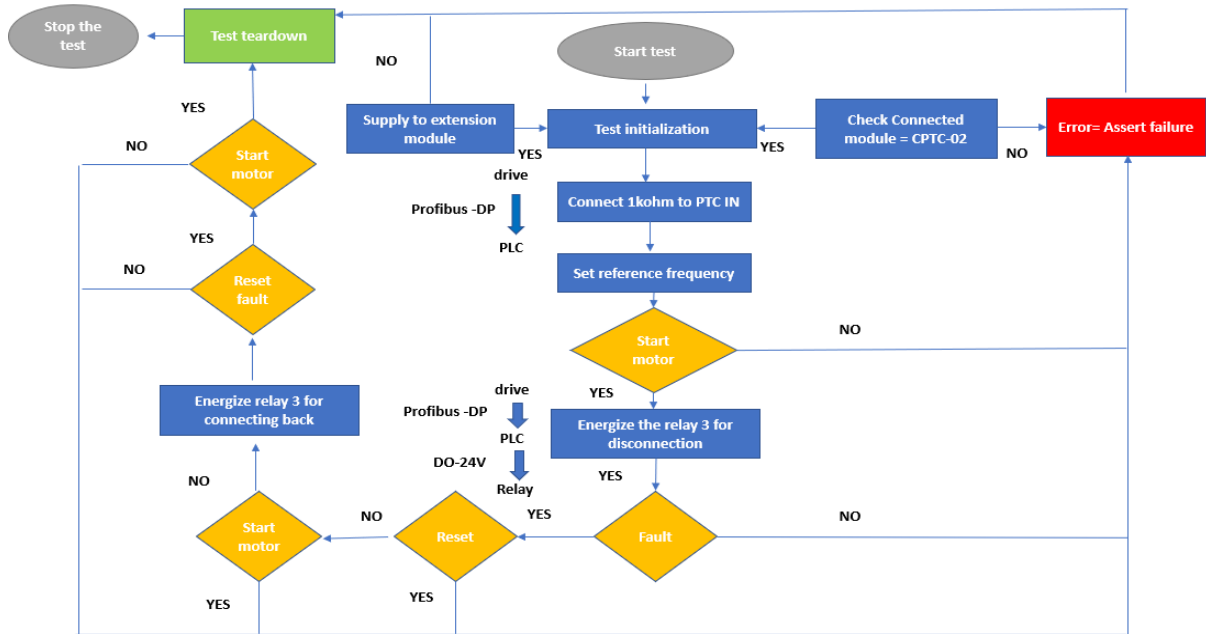

**Figure 3.** Flow Chart for Motor Over Temperature Protection Test

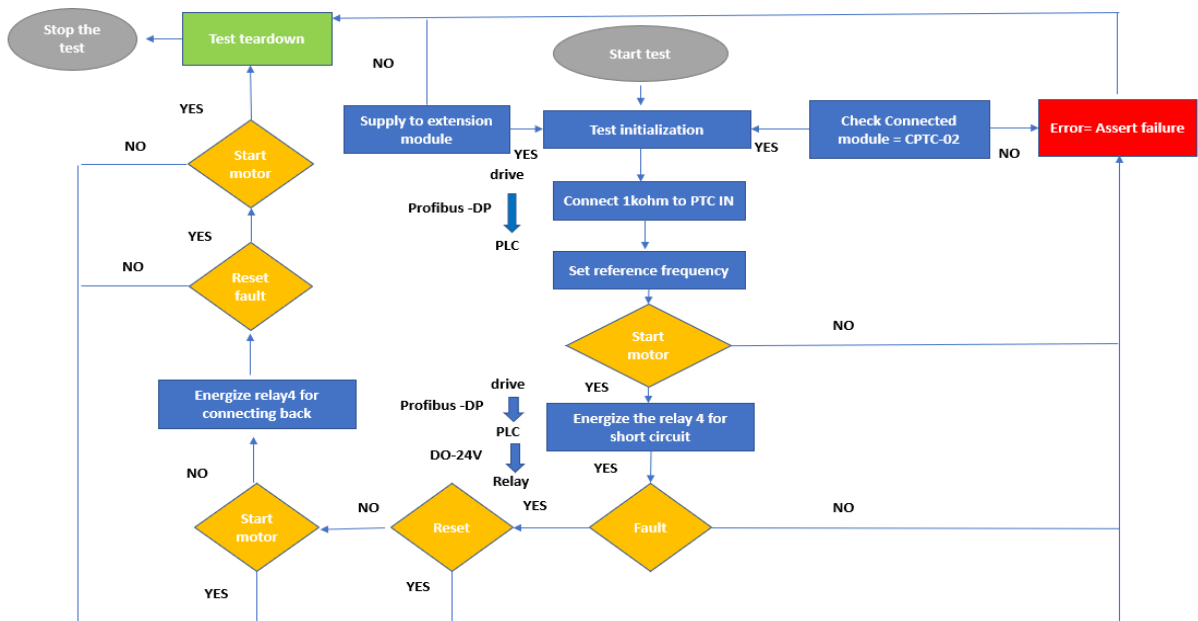
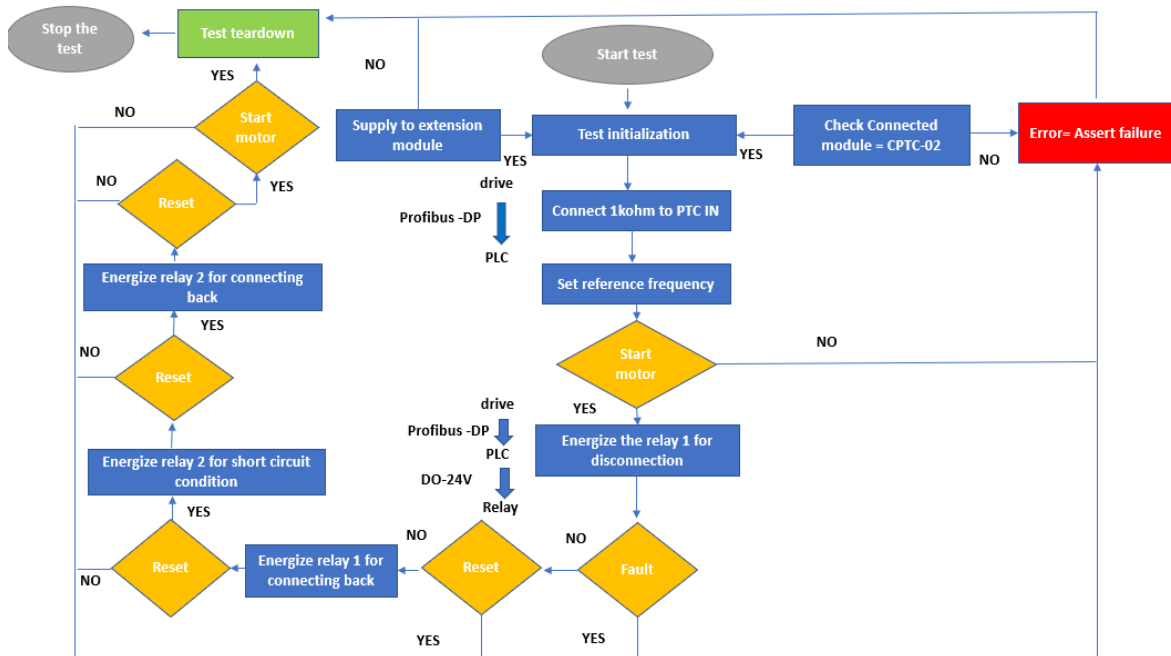

**Figure 4.** Flow Chart for PTC Short Circuit Test

Whenever the drive is in the run condition/no-fault condition [13], the modulating bit should be high. This condition is also satisfying in the below graph and by observing the graph, it can be said that when PTC IN disconnects, the warning bit gets high immediately and it is not resettable; as well as motor does not run until PLC gives a command to the relay to return to the normal condition [14]. The automated test report for this test is shown in Fig. 7.

**2) Automated Test Report of PTC Short Circuit Test:**

From the graph, it is found that, when the short circuit condition occurs, the tripping fault gets high immediately and it is not resettable; as well as the motor cannot run until it does not return to the normal condition (by connecting the back relay to NO condition and 1kohm applied to it). The automated test report for this test is shown in Fig.8.



**Figure 5.** Flow Chart for Relay Malfunctional Test



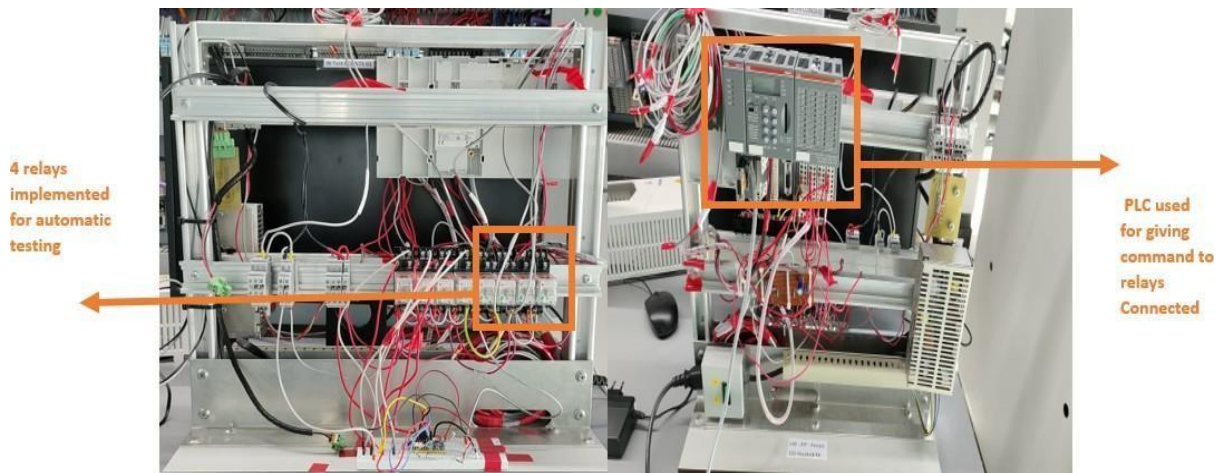
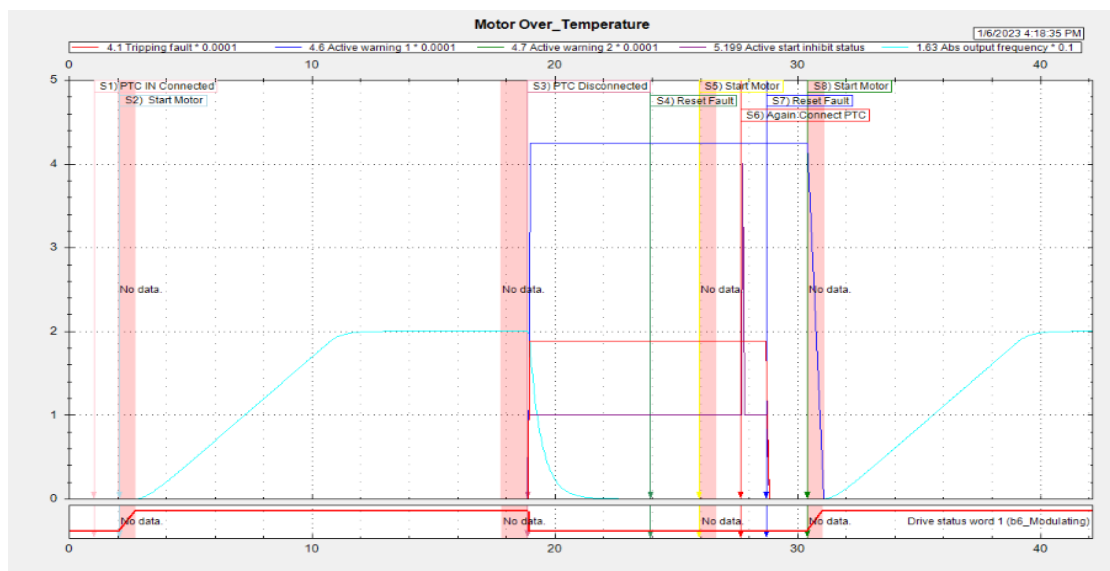

**Figure 6.** Hardware Setup for Automated Testing of Drive

**3) Automated Test Report of Malfunction Test:**

From the graph, it is seen that there are 2 cases to validate malfunction testing. The first case is the disconnection between STO pins of the drive and relay pins of the module, and just after disconnection, the warning gets high till it is connected back to the normal condition.

The second case is of a short circuit connection that occurs between relay pins of the extension module, and the checking occurs immediately if the warning gets high or not. The warning is resettable when it returns to the normal condition. The automated test report for this test is shown in Fig. 9.



**Figure 7.** Test Report of Motor Over Temperature Protection Test

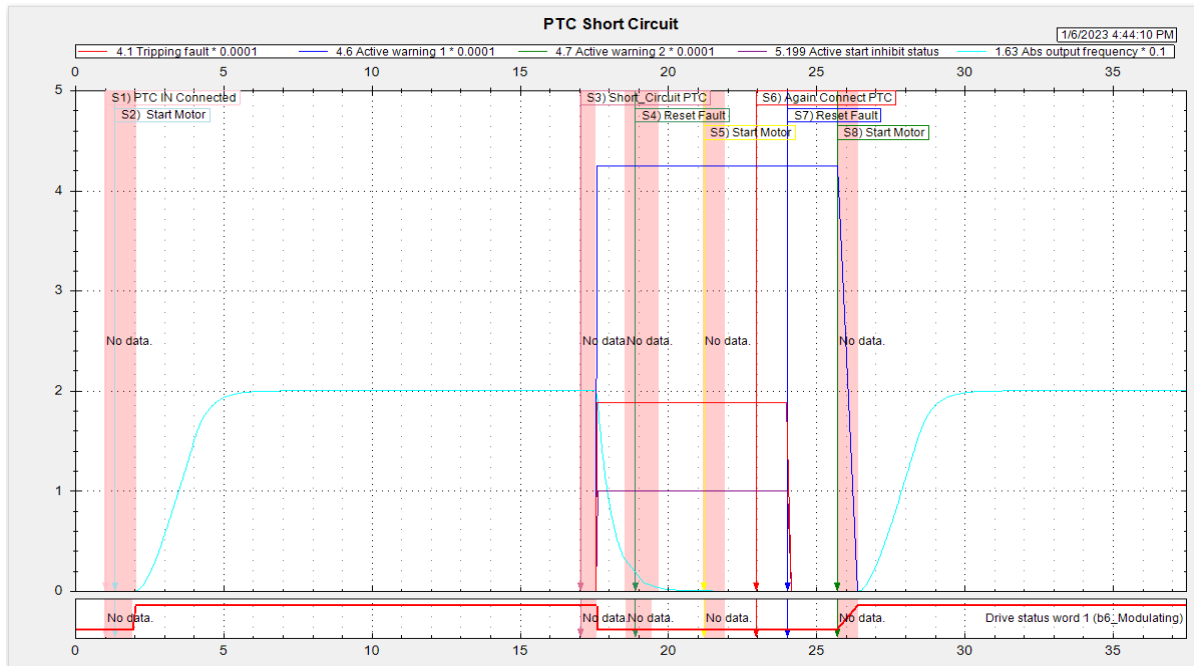

Figure 8. Test Report of PTC Short Circuit Test

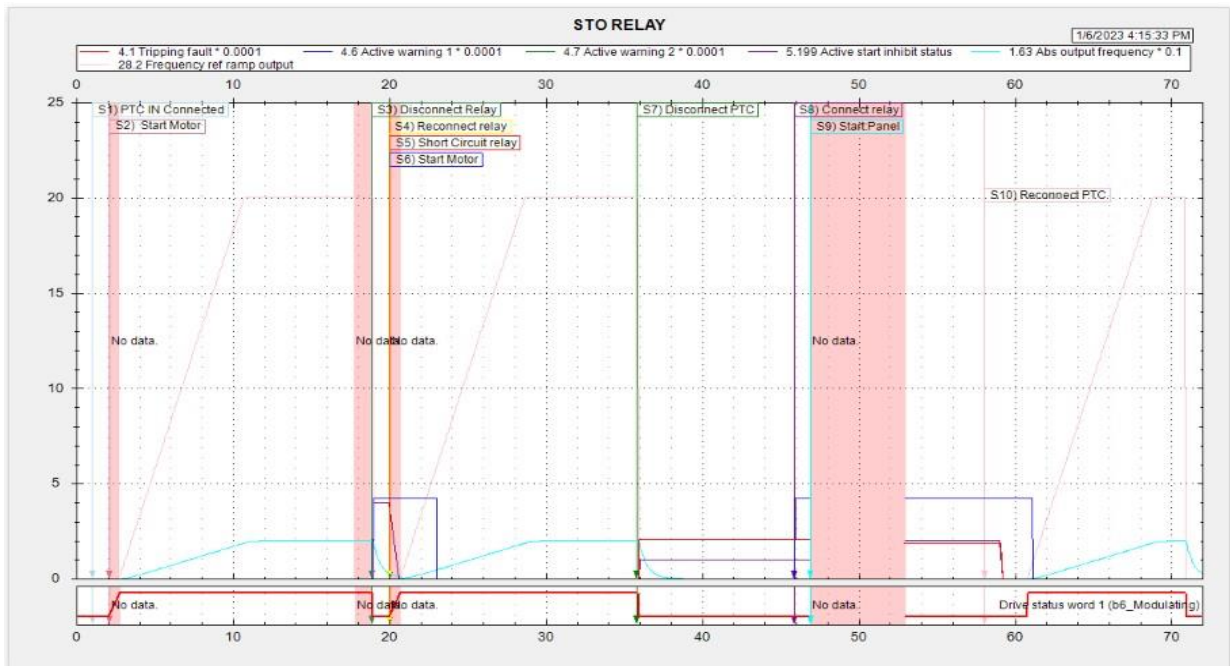

Figure 9. Test Report of Malfunction Test

#### 4. Conclusion

The results of the proposed system show that, due to the test automation of extension modules, all the drawbacks of manual testing have been resolved. Frequent testing along with accuracy is now possible to test the released firmware efficiently. Documentation of results, as well as data logging to observe the test procedures at every step, is now possible after test automation. Moreover, there is no chance of human errors while calibrating complex setups associated with testing procedures. Hence, it can be concluded on the basis of the result that, test automation of the extension module (motor over temperature module) is a promising approach for the industry/organization to increase the productivity of tester team, quality and accuracy of the product produced.

#### References

- [1] D. Winkler, R. Hametner, T. O" streicher, and S. Biffel, "A framework for automated testing of automation systems," 2010 IEEE 15th Conference on Emerging Technologies Factory Automation (ETF A 2010), Bilbao, Spain, 2010, pp. 1-4, doi: 10.1109/ETF A.2010.5641264.
- [2] [https://library.e.abb.com/public/9db5d0a6be7d460585b6a59f160c568b/EN\\_CPTC-02\\_UM\\_E\\_A6.pdf](https://library.e.abb.com/public/9db5d0a6be7d460585b6a59f160c568b/EN_CPTC-02_UM_E_A6.pdf)
- [3] C. Klammer and R. Ramler, "A Journey from Manual Testing to Automated Test Generation in an Industry Project," 2017 IEEE International Conference on Software Quality, Reliability and Security Companion (QRS-C), Prague, Czech Republic, 2017, pp. 591-592, doi: 10.1109/QRS-C.2017.108.
- [4] Z. Liu, Q. Chen, and X. Jiang, "A Maintainability Spreadsheet-Driven Regression Test Automation Framework," 2013 IEEE 16th International Conference on Computational Science and Engineering, Sydney, NSW, Australia, 2013, pp. 1181-1184, doi: 10.1109/CSE.2013.175.
- [5] Z. Sun, Y. Zhang and Y. Yan, "A Web Testing Platform Based on Hybrid Automated Testing Framework," 2019 IEEE 4th Advanced Information Technology, Electronic and Automation Control Conference (IAEAC), Chengdu, China, 2019, pp. 689-692, doi: 10.1109/IAEAC47372.2019.8997684.

- [6] Z. Liu, Q. Chen, and L. Cai, "A file-driven complicated workflow automated test framework," 2015 IEEE International Conference on Information and Automation, Lijiang, China, 2015, pp. 2362-2366, doi: 10.1109/ICInfA.2015.7279681.
- [7] G. P. Rogers and P. Miles, "Manual testing's newfound place in the automated testing world," 2015 IEEE AUTOTESTCON, National Harbor, MD, USA, 2015, pp. 199-202, doi: 10.1109/AUTEST.2015.7356489.
- [8] P. Nigh, "SIA Roadmap: test must not limit future technologies," Proceedings International Test Conference 1998 (IEEE Cat. No.98CH36270), Washington, DC, USA, 1998, pp. 1152-, doi: 10.1109/TEST.1998.743351.
- [9] P. Varma, "System chip test: are we there yet?" Proceedings International Test Conference 1998 (IEEE Cat. No.98CH36270), Washington, DC, USA, 1998, pp. 1144-, doi: 10.1109/TEST.1998.743344.
- [10] S. A. Al-Arian, "Design and test in the universities," Proceedings. 'Meeting the Tests of Time'. , International Test Conference, Washington, DC, USA, 1989, pp. 245-, doi: 10.1109/TEST.1989.82301.\
- [11] A. Bezbaruah, B. Pratap and S. B. Hake, "Automation of Tests and Comparative Analysis between Manual and Automated testing," 2020 IEEE Students Conference on Engineering and Systems (SCES), Prayagraj, India, 2020, pp. 1-5, doi: 10.1109/SCES50439.2020.9236748.
- [12] S. B. Hake and M. Mukhedkar, "Design and Development of Universal Test Bench for Engine Aftertreatment Controls System," in International Journal of Advanced Research in Electronics and Communication Engineering 6(4): 309-312, 2017.
- [13] A. Mouzakitis, A. Nayak, and A., S. Puthiyapurayil, "Automated fault diagnostics testing for automotive Electronic Control Units deploying Hardware-in-the-Loop," in UKACC International Conference on Control. Coventry, Sep. 7-10, 2010
- [14] D. Vashist, N. Kumar, M. Bindra, "Technical Challenges in Shifting from BS IV to BS-VI Automotive Emissions Norms by 2020 in India: A Review," in Archives of Current Research International. 8(1): 1-8, 2017.

- [15] N. M. Raul, N. M. Wagdarikar, C. R. Bhukya, "Development of Hardware-In-Loop Automated Test Bench for Liquid-Assisted After Treatment Controls System's Regression Tests," in International Conference on Computing Communication Control and Automation, Aug. 16-18, 2018
- [16] R. M. Kulkarni, R. P. Patil, C. R. Bhukya, "Hardware-In-Loop Test Bench Based Failure Mode Effects Test," in Automation. International Journal of Innovative Research In Electrical, Electronics, Instrumentation and Control Engineering. 4(10): 27-30, 2016.